

## La Porte Enhancement Grant Application

Please print clearly. Please submit a completed application to:

Office of Economic Development  
City of La Porte  
604 W. Fairmont Parkway  
La Porte, TX 77571

### APPLICANT INFORMATION:

APPLICATION DATE: 03/29/24

Carolyn Howard

Applicant Name

APB Properties, LLC.

Business Name

908 W. Main St.

Physical Business Address

N/A

Business Owner (if different from applicant)

908 W. Main St., La Porte TX 77571

Mailing Address

713-858-4773 ht5709@yahoo.com

Contact Phone Email Address

### TYPE OF WORK (check all that apply):

- Façade
- Awnings/Signage
- Beautification
- Parking Lot Improvements

### DETAILS OF PLANNED IMPROVEMENTS (attach additional pages if necessary):

New Awning, Windows, Doors, Paint

---

---

---

---

---

---

---

---

Please list the name of each Contractor and/or Project Architect and the Total Amount of each bid. Please, also, attach the original proposals and work estimates:

CONTRACTOR/PROJECT ARCHITECT	TOTAL
1. Dream Custom Doors	\$ 72,766
2. Galaxy Construction	\$ 86,220
3. Gonzalez Construction	\$ 86,220
4.	\$
5.	\$

**BUDGET DETAIL**

PROJECT EXPENDITURES	FUNDS	FUNDS APPLIED	TOTAL
Façade Rehab	\$ 72,766	\$	\$ 72,766
Awnings/Signage	\$	\$	\$
Beautification	\$	\$	\$
Parking Lot Improvements	\$	\$	\$
Other (list):	\$	\$	\$
<b>TOTAL</b>	\$	\$	\$

Total estimated cost of proposed project: \$ 72,766  
 Amount requested (up to 50% of total cost, \$2,500 to \$50,000): \$ 36,383

*Please attach color samples, model numbers (for windows, doors, etc.), photos, scaled drawings, and other illustrations of work to be completed. Please include as much detail as possible.*

Your signature on this application certifies that you understand and agree with the following statements: I have met with the LPDC and I fully understand the Enhancement Grant procedures and details established. I intend to use these grant funds for the eligible renovation projects, as spelled out in the application. I have not received, nor will I receive insurance monies for this revitalization project, OR I have disclosed all pertinent insurance information. I understand that if I am awarded an Enhancement Grant, any deviation from the approved project may result in the partial or total withdrawal of the grant funds.

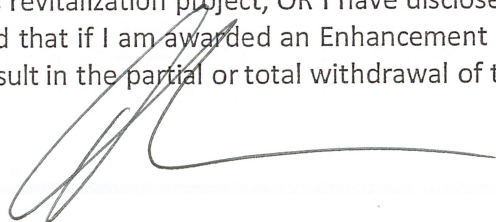

5/7/24

APPLICANT SIGNATURE

DATE

**Gonzalez Construction**

315 San Jacinto  
La Porte, Texas 77571

Daniel Gonzalez  
832-858-0715

<b>INVOICE</b>
[Date]
[Invoice #]

BILL TO	PROJECT INFORMATION
[Name] <i>Carolyn Howard</i>	
[Company Name]	
[Street Address] <i>908 W. Main</i>	
[City, Zipcode] <i>LaPorte Tx 77571</i>	
[Phone] <i>713-858-4773</i>	
[Email]	

DESCRIPTION	TAXED	AMOUNT
<i>Brick Modification 33x33 w/ existing brick allow access welding rods for reinforcement</i>		<i>4,150<sup>00</sup></i>
<i>Interior Work</i>		<i>4,875<sup>00</sup></i>
<i>2 main Entry Doors specs R.O. 9'4" x 5'6 1/4"</i>		<i>19,470<sup>00</sup></i>
<i>    Pulls - 1 1/2 x 20"</i>		
<i>    Frame depth 4"</i>		
<i>    3/4" Glass, insulated, clear</i>		
<i>    Holes thru frame 3/16"</i>		
<i>    Outswing threshold 3/16" (4 of these)</i>		
<i>    Metal awning - 48"</i>		
<i>20 gauge laminate siding <b>Roof Paneling</b></i>		<i><del>21,500</del></i>
<i>14 gauge structural frame</i>		<i>21,580<sup>00</sup></i>
<i>1/4" gauge flat bar anchor</i>		
<i>Window - 1 Active/Transom (40 ft 2)</i>		<i>7800</i>
<i>Window - 2 Active/Transom (44 ft 2)</i>		<i>8120</i>
<i>Window - 3 " " (42 ft 2)</i>		<i>8875</i>
<i>Window - 4 " " (42 ft 2)</i>		<i>8075</i>
<i><b>PAINTING</b></i>		<i>4,075<sup>00</sup></i>

Thank You For Your Business!

**COMMENTS**

---



---



---



---

*+ 3,045*

[Subtotal]	<i>86,220</i>
[Taxable]	\$
[Tax Rate]	
[Tax Due]	\$
[Other]	\$
[Total Due]	<i>83,175<sup>00</sup></i>

Signature: *Daniel Gonzalez*

Date: *5-6-24*  
*3-26-24*

Please make all Checks payable to  
Gonzalez Construction

# ESTIMATE



## Prepared For

Carolyn Howard (Doors)  
908 W Main St  
La Porte , Tx 77571  
(713) 858-4773

## Galaxy Construction LLC

2216 Brookdale Ridge Trace  
Houston, Tx 77089  
Phone: (800) 993-0035  
Email: omar@galaxyconstruction.us  
Fax: (877) 561-7796  
Web: www.galaxyconstruction.us

Estimate # 27  
Date 04/22/2024

## Description

---

### Brick modification

Create an aperture measuring 33 inches by 33 inches within the pre-existing brickwork, allowing for access to the welding machine rods utilized for reinforcing the structure. It's essential to note that these rods serve as the primary means of supporting the entire weight of the awning.

\$4,150.00

---

### Interior wood work

Gently extract the existing window casings and delicately trim the frame to accommodate the new metal window. Galaxy Construction LLC is committed to preserving the historical aesthetic by minimizing harm to pre-existing wooden elements. The property owner is aware of potential rot issues, and Galaxy Construction LLC will promptly replace any deteriorated wood uncovered during the removal of doors and windows.

\$4,875.00

---

### 2 Main entry Doors

2-Single Door TSL 1 (47.5ft2)

Instalation

SHIPMENT

SPECS

- R.O. 9' 4" X 5' 6 1/4"
- SD T SL / OUT SWING LEFT
- PULLS 1 1/2" X 20"
- ROLLER CATCH

- FRAME DEPT 4"
- GLASS 3/4" INSULATED CLEAR
- FINAL PAINTING BLACK MATE IMRON824
- HOLES THROUGH FRAME 3/16"
- THRESHOLD 4 9/16" OUTSWING
- FLASHING
- NO ASSEMBLY (TRANSOM / FRAME)

\$19,470.00

## Metal Awning

1-steel Awning 48ft  
Instalation

### SPECS

- 20 Gauge Laminate metal roof
- 14 Gauge structural Frame
- 1/4" Gauge Flat Bar Anchor
- Flashing
- Primary Painting Epoxy
- Final Painting Black Mate Imron824

\$21,580.00

## Window 1

WINDOW 1 ACTIVE/TRANSOM (40 ft2)  
Instalation

### SPECS

- R.O. 8' 1/4" X 5'
- OUT SWING LEFT HAND
- FRAME DEPT 4"
- WINDOW HANDLE, ARM OPERATOR
- GLASS 3/4" INSULATED CLEAR
- FINAL PAINTING BLACK MATE IMRON824
- HOLES THROUGH FRAME
- NO ASSEMBLY (TRANSOM/FRAME)
- INGES TUBULAR 5/8"

\$7,800.00

## Window 2

WINDOW 2 ACTIVE/TRANSOM (44 ft2)  
Instalation

### SPECS

- R.O. 8' 1/4" X 5' 7 1/4"
- OUT SWING LEFT HAND

- FRAME DEPT 4"
- WINDOW HANDLE, ARM OPERATOR
- GLASS 3/4" INSULATED CLEAR
- FINAL PAINTING BLACK MATE IMRON824
- HOLES THROUGH FRAME
- NO ASSEMBLY (TRANSOM/FRAME)
- INGES TUBULAR 5/8"

\$8,120.00

### Window 3

WINDOW 3 ACTIVE/TRANSOM (42 ft2)

Instalation

#### SPECS

- R.O. 8' 3/4" X 5' 3 3/4"
- OUT SWING LEFT HAND
- FRAME DEPT 4"
- WINDOW HANDLE, ARM OPERATOR
- GLASS 3/4" INSULATED CLEAR
- FINAL PAINTING BLACK MATE IMRON824
- HOLES THROUGH FRAME
- NO ASSEMBLY (TRANSOM/FRAME)
- INGES TUBULAR 5/8"

\$8,075.00

### Window 4

WINDOW 4 ACTIVE/TRANSOM (42 ft2)

Instalation

#### SPECS

- R.O. 8' 1" X 5' 3 3/4"
- OUT SWING LEFT HAND
- FRAME DEPT 4"
- WINDOW HANDLE, ARM OPERATOR
- GLASS 3/4" INSULATED CLEAR
- FINAL PAINTING BLACK MATE IMRON824
- HOLES THROUGH FRAME
- NO ASSEMBLY (TRANSOM/FRAME)
- INGES TUBULAR 5/8"

\$8,075.00

### EXTERIOR PAINTING

One color of paint.

- Caulk siding joints and trim
- Putty all nail holes.

- Primer where needed
- Two coats of paint on exterior of home.
  - Siding/trim
  - Gutters
  - Trim
- \*Customer must choose paint color and paint sheen.
- \*Sherwin Williams products will be used.
- \*One year warranty on labor and materials for painting

\$4,075.00

### Change order

Change orders encompass unexpected elements that can arise during a project, often hidden within structures like walls, insulation, or wood trim. Additionally, they may stem from alterations requested by the property owner.

Adjustments and enhancements will be thoroughly reviewed prior to commencing any work, either through on-site inspection or visual aids such as photographs.

Change orders have the potential to extend the project timeline and, in some cases, introduce additional expenses for necessary adjustments or repairs.

### WARRANTY

5 year warranty on labor  
10 years on materials

---

<b>Subtotal</b>	\$86,220.00
<b>Total</b>	<b>\$86,220.00</b>

By signing this document, the customer agrees to the services and conditions outlined in this document.

---

Carolyn Howard (Doors)





# Dream Custom Doors LLC

## Estimate

For: Carolyn Howard  
 edwin@dreamcustomdoors.com  
 908 W Main St  
 La Porte, TX, 77571-4968

Estimate No: 4  
 Date: 04/22/2024

Description	Quantity	Rate	Amount
Items description	1	\$0.00	\$0.00
1. Steel Awning 48ft			
2. Single Door TSL 1			
3. Single Door TSL 2			
4. Window 1			
5. Window 2			
6. Window 3			
7. Window 4			
Custom Metal Awning & Doors	1	\$14,855.00	\$14,855.00
1-steel Awning 48ft			
Instalation			
SHIPMENT			
Total \$14,755.00			

- SPECS**
- 20 Gauge Laminate Metal Roof
  - 14 Gauge structural Frame
  - 1/4" Gauge Flat Bar Anchor
  - Flashing
  - Primary Painting Epoxy
  - Final Painting Black Mate Imron824

Description	Quantity	Rate	Amount
Single Door 1 Single Door TSL 1 (47.5ft2) Instalation SHIPMENT Total \$7,362.50	1	\$7,400.50	\$7,400.50
SPECS • R.O. 9' 4" X 5' 6 1/4" • SD T SL / OUT SWING LEFT • PULLS 1 1/2" X 20" • ROLLER CATCH • FRAME DEPT 4" • GLASS 3/4" INSULATED CLEAR • FINAL PAINTING BLACK MATE IMRON824 • HOLES THROUGH FRAME 3/16" • THRESHOLD 4 9/16" OUTSWING • FLASHING • NO ASSEMBLY (TRANSOM / FRAME)			
Single Door 2 Single Door TSL 1 (48 ft2) Instalation SHIPMENT Total \$7,440.00	1	\$7,480.00	\$7,480.00
SPECS • R.O. 9' 5" X 5' 6 1/4" • SD T SL/ OUT SWING • ROLLER CATCH • FRAME DEPT 4" • PULLS 1 1/2" X 20" • GLASS 3/4" INSULATED CLEAR • FINAL PAINTING BLACK MATE IMRON824 • HOLES THROUGH FRAME 3/16" • THRESHOLD 4 9/16" OUTSWING • FLASHING • NO ASSEMBLY (TRANSOM / FRAME)			

Description	Quantity	Rate	Amount
Window 1 WINDOW 1 ACTIVE/TRANSOM (40 ft2) Instalation SHIPMENT \$6,200.00	1	\$6,280.00	\$6,280.00
SPECS • R.O. 8' 1/4" X 5' • OUT SWING LEFT HAND • FRAME DEPT 4" • WINDOW HANDLE, ARM OPERATOR • GLASS 3/4" INSULATED CLEAR • FINAL PAINTING BLACK MATE IMRON824 • HOLES THROUGH FRAME • NO ASSEMBLY (TRANSOM/FRAME) • INGES TUBULAR 5/8"			
Window 2 WINDOW 2 ACTIVE/TRANSOM (44 ft2) Instalation SHIPMENT Total \$6,820.00	1	\$6,880.00	\$6,880.00
SPECS • R.O. 8' 1/4" X 5' 7 1/4" • OUT SWING LEFT HAND • FRAME DEPT 4" • WINDOW HANDLE, ARM OPERATOR • GLASS 3/4" INSULATED CLEAR • FINAL PAINTING BLACK MATE IMRON824 • HOLES THROUGH FRAME • NO ASSEMBLY (TRANSOM/FRAME) • INGES TUBULAR 5/8"			
Window 3 WINDOW 3 ACTIVE/TRANSOM (42 ft2) Instalation SHIPMENT Total \$6,510.00	1	\$6,570.00	\$6,570.00
SPECS • R.O. 8' 3/4" X 5' 3 3/4" • OUT SWING LEFT HAND • FRAME DEPT 4" • WINDOW HANDLE, ARM OPERATOR • GLASS 3/4" INSULATED CLEAR • FINAL PAINTING BLACK MATE IMRON824 • HOLES THROUGH FRAME • NO ASSEMBLY (TRANSOM/FRAME) • INGES TUBULAR 5/8"			

Description	Quantity	Rate	Amount
Window 4 WINDOW 4 ACTIVE/TRANSOM (42 ft2) Instalation SHIPMENT \$6,510.00	1	\$6,570.00	\$6,570.00
SPECS • R.O. 8' 1" X 5' 3 3/4" • OUT SWING LEFT HAND • FRAME DEPT 4" • WINDOW HANDLE, ARM OPERATOR • GLASS 3/4" INSULATED CLEAR • FINAL PAINTING BLACK MATE IMRON824 • HOLES THROUGH FRAME • NO ASSEMBLY (TRANSOM/FRAME) • INGES TUBULAR 5/8"			
Brick removal & steel bars reinforcement Remove a 33"x33" area of pre-existing brick and open area to access welding machine rods for reinforcement. Keep in mind, these are main sources of support for entire weight of the awning, proper strength and reinforcement is critical. Welding is needed to add additional support will be an extra cost and will be added in a change order	1	\$3,650.00	\$3,650.00
Carpentry Work Carefully remove window casings and cutt out frame to fit new metal window. Dream custom Doors will do their best to not damage any pre-existing wood to keep historical look/image. Property owner understands there are rotted & deteriorated wood/boards. Dream Custom Doors LLC will replace any rotted wood found	1	\$3,785.00	\$3,785.00
Painting of outside brick Paint all exterior brick to match (green) \$3,750.00 Material and labor	1	\$3,750.00	\$3,750.00
Change Order Change orders are unforeseen items that may occur with project. Things that cannot be seen behind a wall, insulation, wood trim etc.. Also modifications added by property owner. - Changes/Additions Will be discussed prior to work being performed. Shown at location or pictures. - Change orders may delay the project & can potentially add cost for repairs.	1	\$0.00	\$0.00
Permits & Inspections Permits & inspections are not included in this estimate. The City of La Porte will determine permit fees & windstorm inspections fees  5 year warranty in labor and 15 years on materials	1	\$0.00	\$0.00

Dream Custom Doors LLC - Estimate 4 - 04/22/2024

Subtotal	\$67,220.50
TAX 8.25%	\$5,545.69
Total	\$72,766.19

**Total \$72,766.19**



# DREAM CUSTOM DOORS®

**HANDFORGED IRON**

HOUSTON, TEXAS, USA

www.dreamcustomdoors.com

Design:  
COMMERCIAL  
AWNING,  
CAROLYN HOWARD  
908 W Main St, La  
Porte, TX 77571, U.S



AA PROPOSED REAR VIEW  
Main

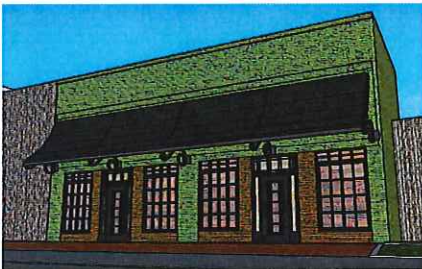

AA PROPOSED REAR VIEW  
Main

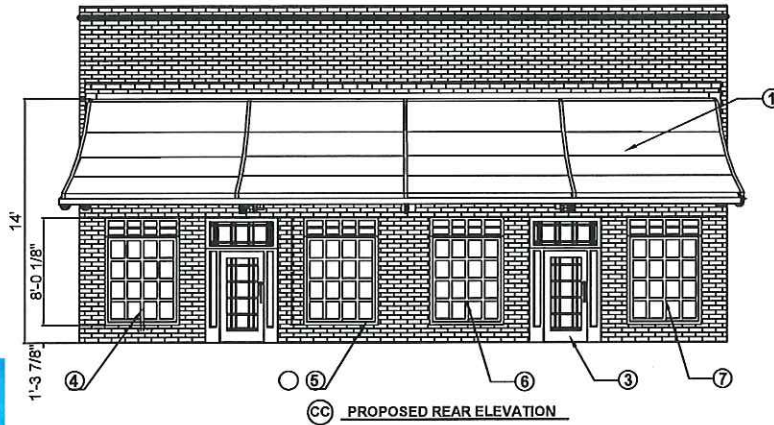

CC PROPOSED REAR ELEVATION

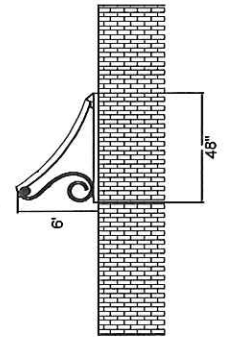

CC PROPOSED LEFT ELEVATION



BB EXISTING REAR VIEW  
Main St.

### ITEMS

- ① Steel Awning 48ft
- ② Single Door TSL 1
- ③ Single Door TSL 2
- ④ Window 1
- ⑤ Window 2
- ⑥ Window 3
- ⑦ Window 4

"THIS DRAWING IS FOR A SAMPLE ONLY,  
NOT AUTHORIZED BY DREAM CUSTOM  
DOORS ENGINEERING FOR PRODUCTION,  
SAMPLE ONLY."

DESIGN APPROVED BY: \_\_\_\_\_

DATE APPROVED \_\_\_\_\_

DESIGN:	CUSTOM
FILE:	HO0-004-D00
DATE:	08-17-2023
DESIGNER CAD:	E.J.Z.N.



**DREAM**  
**CUSTOM DOORS®**  
**HANDFORGED IRON**  
 HOUSTON, TEXAS, USA  
 www.dreamcustomdoors.com

① Steel Awning 48ft

Awning 48' x 6' (Concave)  
 20 Gauge Laminate Siding  
 14 Gauge Structural Frame  
 1/4" Gauge Flat Bar Anchor  
 Flashing

Primary Painting Epoxy

Final Painting Black Mate Imron824 (Gloss black Support)

Design:  
 COMMERCIAL  
 AWNING,  
 CAROLYN HOWARD  
 908 W Main St, La  
 Porte, TX 77571, U.S

① Steel Awning 48ft

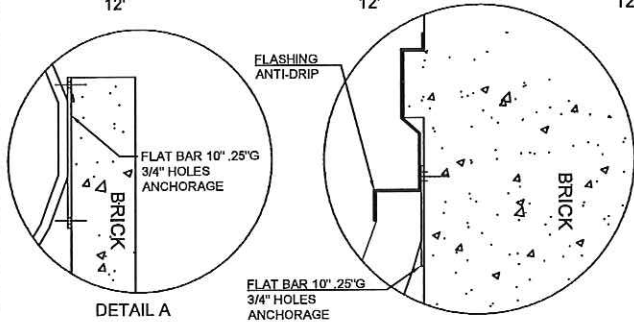
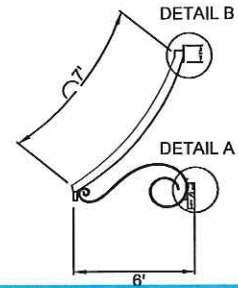
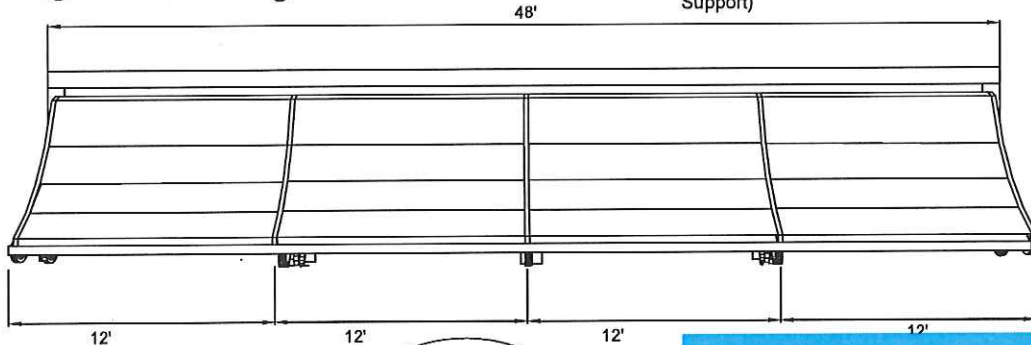

"THIS DRAWING IS FOR A SAMPLE ONLY,  
 NOT AUTHORIZED BY DREAM CUSTOM  
 DOORS ENGINEERING FOR PRODUCTION,  
 SAMPLE ONLY."

DESIGN APPROVED BY: \_\_\_\_\_

DATE APPROVED \_\_\_\_\_

DESIGN:	CUSTOM
FILE:	HO0-004-D00
DATE:	08-17-2023
DESIGNER CAD:	E.J.Z.N.



# DREAM CUSTOM DOORS

**HANDFORGED IRON**

HOUSTON, TEXAS, USA

[www.dreamcustomdoors.com](http://www.dreamcustomdoors.com)

Design:  
COMMERCIAL  
AWNING,  
CAROLYN HOWARD  
908 W Main St, La  
Porte, TX 77571, U.S

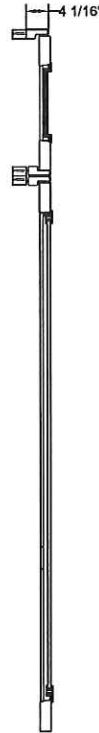
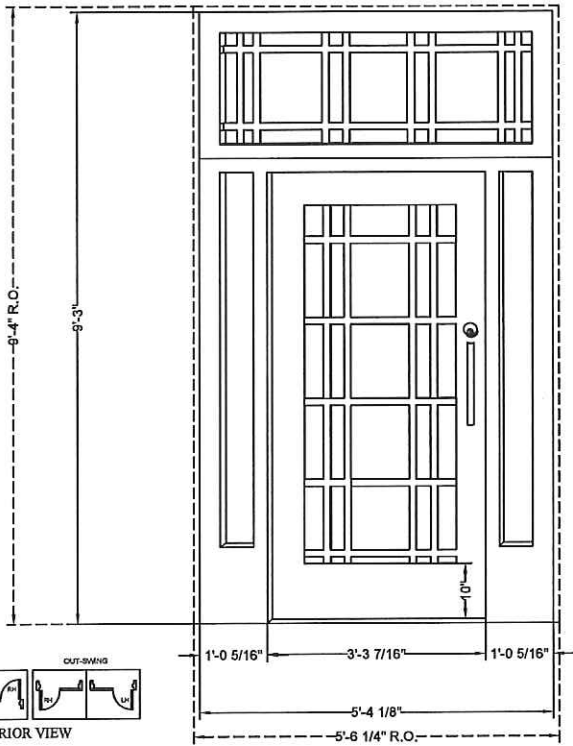

## ② Single Door TSL 1

- R.O. 9' 4" x 5' 6 1/4"
- SD T SL / OUT SWING LEFT
- ROLLER CATCH
- FRAME DEPT 4"
- GLASS 3/4" INSULATED CLEAR
- Final Painting Gloss Black Imron824
- HOLES THROUGH FRAME
- THRESHOLD 4 9/16" OUTSWING
- Flashing
- No Assembly (Transom/Frame)

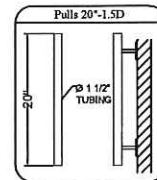

"THIS DRAWING IS FOR A SAMPLE ONLY,  
NOT AUTHORIZED BY DREAM CUSTOM  
DOORS ENGINEERING FOR PRODUCTION,  
SAMPLE ONLY."

DESIGN APPROVED BY: \_\_\_\_\_

DATE APPROVED \_\_\_\_\_

DESIGN:	CUSTOM
FILE:	H00-004-D00
DATE:	08-17-2023
DESIGNER CAD:	E.J.Z.N.





# DREAM CUSTOM DOORS

**HANDFORGED IRON**

HOUSTON, TEXAS, USA

[www.dreamcustomdoors.com](http://www.dreamcustomdoors.com)

Design:  
COMMERCIAL  
AWNING,  
CAROLYN HOWARD  
908 W Main St, La  
Porte, TX 77571, U.S

### ③ Single Door TSL 1

R.O. 9' 5" x 5' 6 1/4"  
SD T SL / OUT SWING RIGHT  
ROLLER CATCH  
FRAME DEPT 4"  
GLASS 3/4" INSULATED CLEAR  
Final Painting Gloss Black Imron824  
HOLES THROUGH FRAME  
THRESHOLD 4 9/16" OUTSWING  
Flashing  
No Assembly (Transom/Frame)

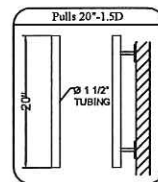
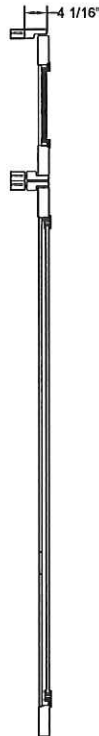
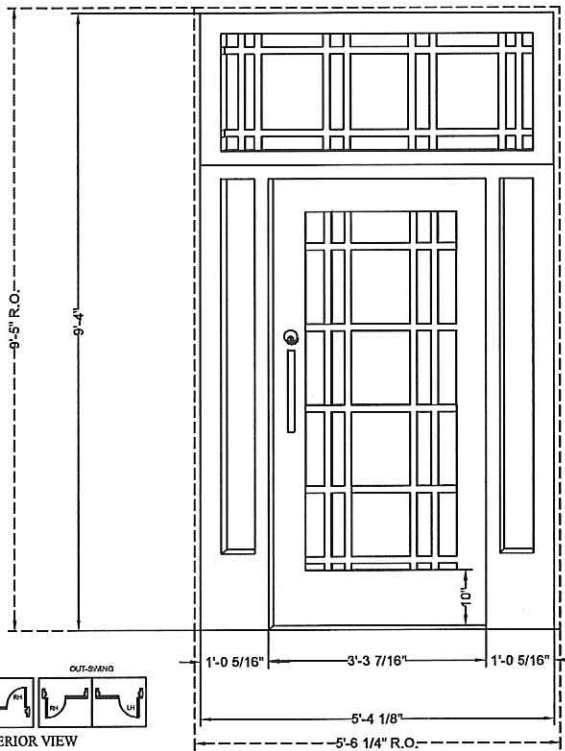

"THIS DRAWING IS FOR A SAMPLE ONLY,  
NOT AUTHORIZED BY DREAM CUSTOM  
DOORS ENGINEERING FOR PRODUCTION,  
SAMPLE ONLY."

DESIGN APPROVED BY: \_\_\_\_\_

DATE APPROVED \_\_\_\_\_

DESIGN:	CUSTOM
FILE:	H00-004-D00
DATE:	08-17-2023
DESIGNER CAD:	E. J. Z. N.



**DREAM  
CUSTOM DOORS**

**HANDFORGED IRON**

HOUSTON, TEXAS, USA

[www.dreamcustomdoors.com](http://www.dreamcustomdoors.com)

Design:  
COMMERCIAL  
AWNING,  
CAROLYN HOWARD  
908 W Main St, La  
Porte, TX 77571, U.S

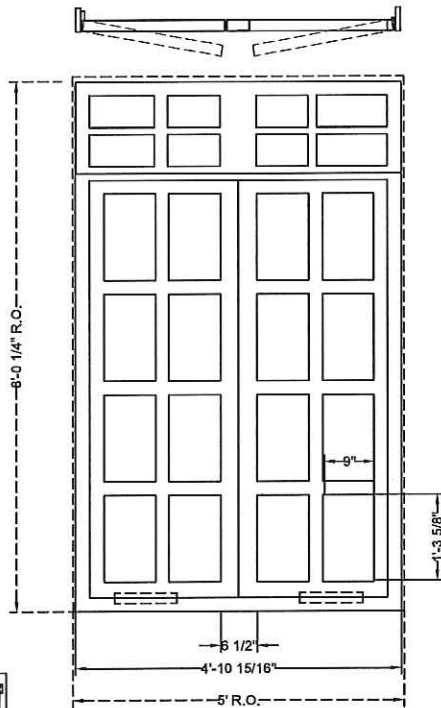

④ Window 1

R.O. 8' 1/4" x 5'  
OUT SWING LEFT HAND  
FRAME DEPT 4"  
WINDOW HANDLE  
ARM OPERATOR  
GLASS 3/4" INSULATED CLEAR  
Final Painting Gloss Black Imron824  
HOLES THROUGH FRAME  
No Assembly (Transom/Frame)  
HINGES TUBULAR 5/8"

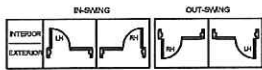

EXTERIOR VIEW

"THIS DRAWING IS FOR A SAMPLE ONLY,  
NOT AUTHORIZED BY DREAM CUSTOM  
DOORS ENGINEERING FOR PRODUCTION,  
SAMPLE ONLY."

DESIGN APPROVED BY: \_\_\_\_\_

DATE APPROVED \_\_\_\_\_

DESIGN:	CUSTOM
FILE:	H00-004-D00
DATE:	08-17-2023
DESIGNER CAD:	E.J.Z.N.



# DREAM CUSTOM DOORS

**HANDFORGED IRON**

HOUSTON, TEXAS, USA

[www.dreamcustomdoors.com](http://www.dreamcustomdoors.com)

Design:  
COMMERCIAL  
AWNING,  
CAROLYN HOWARD  
908 W Main St, La  
Porte, TX 77571, U.S

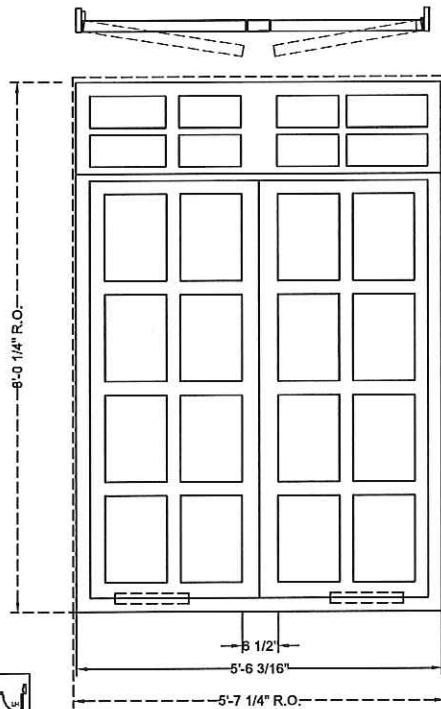

## ⑤ Window 2

R.O. 8' 1/4" x 5' 7 1/4"  
 OUT SWING RIGHT HAND  
 FRAME DEPT 4"  
 WINDOW HANDLE  
 ARM OPERATOR  
 GLASS 3/4" INSULATED CLEAR  
 Final Painting Gloss Black Imron824  
 HOLES THROUGH FRAME  
 No Assembly (Transom/Frame)  
 HINGES TUBULAR 5/8"

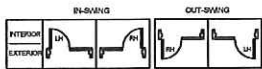

EXTERIOR VIEW

"THIS DRAWING IS FOR A SAMPLE ONLY,  
NOT AUTHORIZED BY DREAM CUSTOM  
DOORS ENGINEERING FOR PRODUCTION,  
SAMPLE ONLY."

DESIGN APPROVED BY: \_\_\_\_\_

DATE APPROVED \_\_\_\_\_

DESIGN:	CUSTOM
FILE:	H00-004-D00
DATE:	08-17-2023
DESIGNER CAD:	E.J.Z.N.



# DREAM CUSTOM DOORS

**HANDFORGED IRON**

HOUSTON, TEXAS, USA

[www.dreamcustomdoors.com](http://www.dreamcustomdoors.com)

Design:  
COMMERCIAL  
AWNING,  
CAROLYN HOWARD  
908 W Main St, La  
Porte, TX 77571, U.S

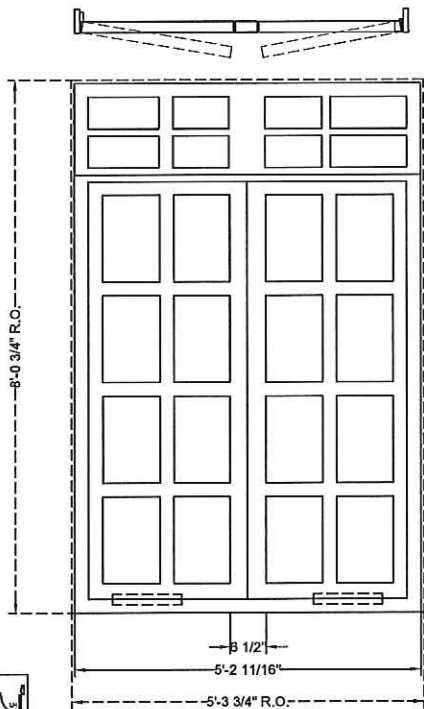

## ⑥ Window 3

R.O. 8' 3/4" x 5' 3 3/4"  
 OUT SWING LEFT HAND  
 FRAME DEPT 4"  
 WINDOW HANDLE  
 ARM OPERATOR  
 GLASS 3/4" INSULATED CLEAR  
 Final Painting Gloss Black Imron824  
 HOLES THROUGH FRAME  
 No Assembly (Transom/Frame)  
 HINGES TUBULAR 5/8"



EXTERIOR VIEW

"THIS DRAWING IS FOR A SAMPLE ONLY,  
NOT AUTHORIZED BY DREAM CUSTOM  
DOORS ENGINEERING FOR PRODUCTION,  
SAMPLE ONLY."

DESIGN APPROVED BY: \_\_\_\_\_

DATE APPROVED \_\_\_\_\_

DESIGN:	CUSTOM
FILE:	HO0-004-D00
DATE:	08-17-2023
DESIGNER CAD:	E.J.Z.N.



**DREAM  
CUSTOM DOORS**

**HANDFORGED IRON**

HOUSTON, TEXAS, USA

www.dreamcustomdoors.com

Design:  
COMMERCIAL  
AWNING,  
CAROLYN HOWARD  
908 W Main St, La  
Porte, TX 77571, U.S

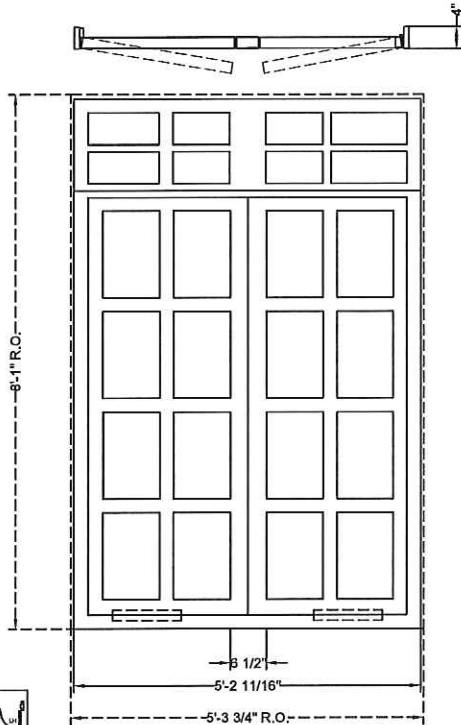

⑦ Window 4

R.O. 8' 1" x 5' 3 3/4"  
OUT SWING RIGHT HAND  
FRAME DEPT 4"  
WINDOW HANDLE  
ARM OPERATOR  
GLASS 3/4" INSULATED CLEAR  
Final Painting Gloss Black Imron824  
HOLES THROUGH FRAME  
No Assembly (Transom/Frame)  
HINGES TUBULAR 5/8"

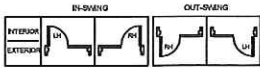

EXTERIOR VIEW

"THIS DRAWING IS FOR A SAMPLE ONLY,  
NOT AUTHORIZED BY DREAM CUSTOM  
DOORS ENGINEERING FOR PRODUCTION,  
SAMPLE ONLY."

DESIGN APPROVED BY: \_\_\_\_\_

DATE APPROVED \_\_\_\_\_

DESIGN:	CUSTOM
FILE:	H00-004-D00
DATE:	08-17-2023
DESIGNER CAD:	E.J.Z.N.

bath salts 624

feather green 625

etched glass 626

spring break 627

winchester sage 628

weeping willow 629

BENJAMIN MOORE®  
063